

Lower Thames Crossing

9.73 Tunnel Depth Report (Clean version)

Infrastructure Planning (Examination
Procedure) Rules 2010

Volume 9

DATE: November 2023
DEADLINE: 7

Planning Inspectorate Scheme Ref: TR010032
Examination Document Ref: TR010032/EXAM/9.73

VERSION: 3.0

Revision history

| Version | Date | Submitted at |
|---------|------------------|--------------|
| 1.0 | 24 August 2023 | Deadline 3 |
| 2.0 | 31 October 2023 | Deadline 6 |
| 3.0 | 17 November 2023 | Deadline 7 |

Lower Thames Crossing

9.73 Tunnel Depth Report (Clean version)

List of contents

| | Page number |
|---|-------------|
| 1 Executive summary | 1 |
| 2 Introduction | 2 |
| 2.1 Background..... | 2 |
| 2.2 Purpose of this report | 5 |
| 2.3 Update at Deadline 6 | 5 |
| 3 Depth of the tunnel | 6 |
| 4 Implications on assessments | 9 |
| 4.1 Flotation | 9 |
| 4.2 Assessment of reasonable alternatives | 9 |
| 4.3 Marine biodiversity | 9 |
| 5 Implications on the draft DCO | 10 |
| 5.1 Drafting at Deadline 3 | 10 |
| 5.2 Proposed amendments to the draft DCO..... | 10 |
| 5.3 Deadline 7 Update | 11 |
| 5.4 Provisions of the draft DCO | 11 |
| 6 Implications on Statement of Reasons | 13 |
| 6.1 Basis of the protection zone..... | 13 |
| References | 14 |
| Glossary | 15 |
| Appendix A Flotation sensitivity check to satisfy future riverbed levels | 17 |
| Appendix B Flotation report update: scour protection allowance | 25 |
| References | 26 |
| Glossary | 27 |
| Annexes | 29 |
| Annex A Tunnel profile and geological section | 30 |
| Annex B Technical note – LTC propeller scour protection | 32 |

List of plates

| | Page number |
|---|--------------------|
| Plate 3.1 Cross-section of river showing reference design, LOD and protection zones..... | 7 |
| Plate 6.1 Illustrative cross-section showing the zone of protection and exclusion zone | 13 |
| Plate A.1 Assessed tunnel section..... | 20 |
| Plate A.2 Shear design case..... | 22 |

List of tables

| | Page number |
|--|--------------------|
| Table 3.1 Levels of cover..... | 8 |
| Table A.1 Analysis sections considered for flotation assessment..... | 20 |
| Table A.2 Section levels | 21 |
| Table A.3 Flotation results | 23 |

1 Executive summary

- 1.1.1 The Port of London Authority (PLA) have raised a number of matters relating to the depth of the tunnel and the restrictions in the river, with a focus on seeking to ensure that the tunnel would be of sufficient depth to accommodate both current and future river trade and that the tunnel does not compromise the future development of the port or navigation. The Port of Tilbury London Limited have supported the position of the PLA.
- 1.1.2 It has also been noted by the Applicant and by the PLA that there is an inconsistency regarding the minimum amount of cover above the tunnels reported in the Application Documents.
- 1.1.3 This document provides clarifications on the tunnel depth, the limits of deviation, and the layer of cover. It sets out that on a precautionary basis considering the existing river depth, the upper limit of deviation, with an allowance for the deepening of the navigable channel and a further allowance for the future installation of scour protection, there would be a level of cover at the minimum point of 0.52 times the tunnel diameter. Note that scour protection is not proposed by the Applicant, but has been considered on a precautionary basis following discussion with the PLA.
- 1.1.4 The report sets out the relevant assessments and confirms that, with a minimum level of cover of 0.52 times the tunnel diameter, the road tunnels would remain stable and that the environmental assessments remain valid.
- 1.1.5 The report provides a further update on article 33 of the draft DCO [\[REP5-024\]](#), which sets out the rights to acquire subsoil, and provides an alternative drafting relating to the datum used for the River Thames that is being considered to address potential uncertainties that could arise from the current drafting.

2 Introduction

2.1 Background

Signposting relevant parts of the application

2.1.1 The A122 Lower Thames Crossing (the Project) includes two tunnels under the River Thames, which provide for the new road. These tunnels will be constructed in accordance with the requirements set out within the draft Development Consent Order (DCO) (resubmitted at D3) and the associated controls, and restrictions will be placed onto the river in proximity to the tunnel. Key elements of the application include (but are not limited to):

- a. The draft DCO [\[REP5-024\]](#):
 - i. article 6(1)(c) relating to limits of deviation
 - ii. article 33 relating to the acquisition of subsoil
 - iii. article 48 relating to protection of the tunnel area
 - iv. Schedule 10 – Land in which only subsoil or new rights in and above subsoil and surface may be acquired
 - v. Schedule 14 – Protective Provisions, Part 8 – For the Protection of the Port of London Authority
- b. River Restrictions Plans [\[REP1-041\]](#)
- c. Tunnel Limits of Deviation Plans [\[REP4-074\]](#)
- d. Statement of Reasons [\[REP5-028\]](#):
 - i. Section 5.4 sets out the tunnel zone of protection and exclusion zone, the proposals to acquire the subsoil within which the tunnels would lie and the proposals to acquire rights and impose restrictive covenants in the area identified as the zone of protection
 - ii. Table 3 of Statement of Reasons Annex A sets out the purpose for which rights are required, on a plot by plot basis
- e. Book of Reference [\[REP5-030\]](#)
- f. Land Plans (Volume B) (Sheets 1 to 20) [\[REP5-006\]](#): sheets 15 and 16

- 2.1.2 Under the River Thames, the tunnelling activity is a subsurface activity, with no impact on the riverbed, although there may be a need for geotechnical investigations to take place prior to the tunnelling. Nevertheless, potential noise impacts from the tunnel boring machine on marine life have been considered as reported in Environmental Statement (ES) Chapter 9: Marine Biodiversity [APP-147] supported by analysis reported in ES Appendix 9.1: Assessment of Ground-Borne Noise and Vibration, and Underwater Noise from the Tunnel Boring Machine at Marine Receptors [APP-420]. A clarification to the wording of this assessment was provided in the ES Addendum [REP5-062].
- 2.1.3 It has been noted by the Applicant and by the Port of London Authority (PLA) that there is an inconsistency regarding the minimum amount of cover above the tunnels reported in the Application Documents, as follows:
- a. Plate 5.1 of the Statement of Reasons indicates an exclusion zone of 0.7 times the tunnel diameter, and a zone of protection above this implying the tunnel is at some depth greater than 0.7 times the tunnel diameter.
 - b. Table 3.15 of ES Chapter 3: Assessment of Reasonable Alternatives [APP-141] indicates that the minimum cover to the tunnel under the River Thames was reduced to 1.0 times the outer diameter of the tunnel.
 - c. The wording of the ES Chapter 9: Marine Biodiversity [APP-147] indicated a layer of cover of at least 0.9 times the tunnel diameter, before this was amended by the ES Addendum [REP5-062].

Matters raised in engagement

- 2.1.4 The PLA have raised a number of matters relating to the depth of the tunnel and the restrictions in the river, with a focus on seeking to ensure that the tunnel would be of sufficient depth to accommodate both current and future river trade and that the tunnel does not compromise the future development of the port or navigation. The Port of Tilbury London Limited have supported the position of the PLA.
- 2.1.5 Particular issues raised by the PLA are set out in the Statement of Common Ground between National Highways and the Port of London Authority [APP-100], including the following:
- a. Item 2.1.12 – Article 6 - Limits of deviation (DCO)
 - b. Item 2.1.31 – Compulsory Acquisition powers in favour of National Highways
 - c. Item 2.1.34 – Route alignment, tunnel depth and tunnel protection zones
 - d. Item 2.1.40 – Scour Protection
 - e. Item 2.1.41 – Works within the river

- 2.1.6 Further information has been provided by the PLA in their Relevant Representation [[RR-0862](#)] and their oral and written submissions into the Examination.
- 2.1.7 A critical matter raised by the PLA has been the potential that they may at some point in the future seek to deepen the navigable channel. Such an activity would result in a change in the level of the riverbed, and as such there is a level of uncertainty over the level of cover over the tunnel during construction and operation. The potential for this dredging to take place prior to construction of the tunnel has increased as a result of the two year rephase announced in the Written Ministerial Statement of 9 March 2023 (UK Parliament, 2023).
- 2.1.8 The PLA have raised concerns that the Lower Thames Crossing tunnel, when accounting for the restrictions placed on activities around it, would result in an increase in the requirements that would have to be met by PLA if they were to increase the depth of the navigable channel, and that these requirements could be such that it would not be possible to dredge, or that such dredging would impact on the ability of the Applicant to deliver the Project:
- a. If the increase in the depth of the navigable channel were to take place after construction of the Project:
 - i. The PLA are concerned that a deeper navigable channel would reduce cover over the tunnel, resulting in instability (flotation) of the tunnel, thereby presenting a safety risk that would prevent an increase in the depth of the navigable channel.
 - ii. The PLA are concerned that if in the future there were to be a need for scour protection, the installation of such scour protection would lead to a reduction in the depth of the navigable channel. It should be noted that the Applicant considers that no such scour protection is needed and is not seeking consent for scour protection, but the PLA seek reassurance that scour protection could be implemented at some future date on a precautionary basis, considering the changeable nature of the river.
 - b. If the increase in the depth of the navigable channel were to take place before construction of the Project:
 - i. The PLA seek assurance that the rights over land sought by the Applicant remain correct, considering the change in the riverbed level.
 - ii. The PLA seek assurance that the assessments of impacts remain valid, and that there would not be new or materially different environmental effects that would prevent the implementation of the Project.
 - iii. The PLA are concerned that a deeper navigable channel would reduce cover over the tunnel, resulting in instability (flotation) of the tunnel.

2.2 Purpose of this report

- 2.2.1 This report has been prepared to address the following concerns:
- a. Address the inconsistencies in the level of cover throughout the DCO application
 - b. Address the concerns of the PLA
 - c. Explain modifications to the drafting of the draft DCO that are being considered to address the concerns of the PLA

2.3 Update at Deadline 6

- 2.3.1 The Applicant met with the PLA on 06 October 2023 providing further information relating to scour protection, as presented in Annex B, and an update to the technical report on Flotation sensitivity check to satisfy future riverbed levels, as presented in Appendix B.
- 2.3.2 The tunnel has been assessed at both the vertical alignment proposed in the reference design for DCO, and the upper Limits of Deviation (LOD) being sought in the DCO. The case at the upper LOD is the most conservative case; the reference design case is a more likely scenario. The results of the assessment show that the flotation calculations satisfy the stability criteria for all tunnel horizons and riverbed levels considered. The report concluded that there is no impediment to the agreed dredging levels being secured. If development consent is granted, further detailed plans would be submitted to the PLA in connection with the tunnelling works (as per paragraph 99 of Schedule 14 of the draft DCO [\[REP5-024\]](#)).
- 2.3.3 The Applicant awaits further considerations or comments from the PLA and will continue to discuss and refine this issue.

3 Depth of the tunnel

- 3.1.1 The tunnel reference design is shown on the Tunnel Limits of Deviation Plans [\[REP4-074\]](#). These plans also show the vertical upwards limit (limit of deviation (LOD)).
- 3.1.2 The depth of the tunnel varies along the cross-section of the river, as both the level of the riverbed changes and the tunnel depth changes relative to a fixed datum.
- 3.1.3 The level of cover over the tunnel is at a minimum on the northern edge of the navigable channel as shown in Plate 3.1.
- 3.1.4 At this point in the river channel, the level of cover in different scenarios is as set out in Table 3.1. These scenarios are each considered in the flotation assessment included as Appendix A.
- 3.1.5 In the most precautionary scenario (i.e. where the level of cover is at the minimum), characterised in Table 3.1 as “Additional section 1”, the tunnel is constructed at the highest level allowed by the LOD while the riverbed is at its lowest level, allowing both for the PLA to dredge to -16.12m AOD (plus 0.5m allowance for over dredging) and the precautionary allowance for further dredging to install any scour protection (-1.3m). The combined effects of dredging would leave a riverbed of -17.42m above ordnance datum (AOD). In this scenario the level of cover over the tunnel would be 8.3m, or 0.52 times the tunnel diameter (0.52D).

Plate 3.1 Cross-section of river showing reference design, LOD and protection zones

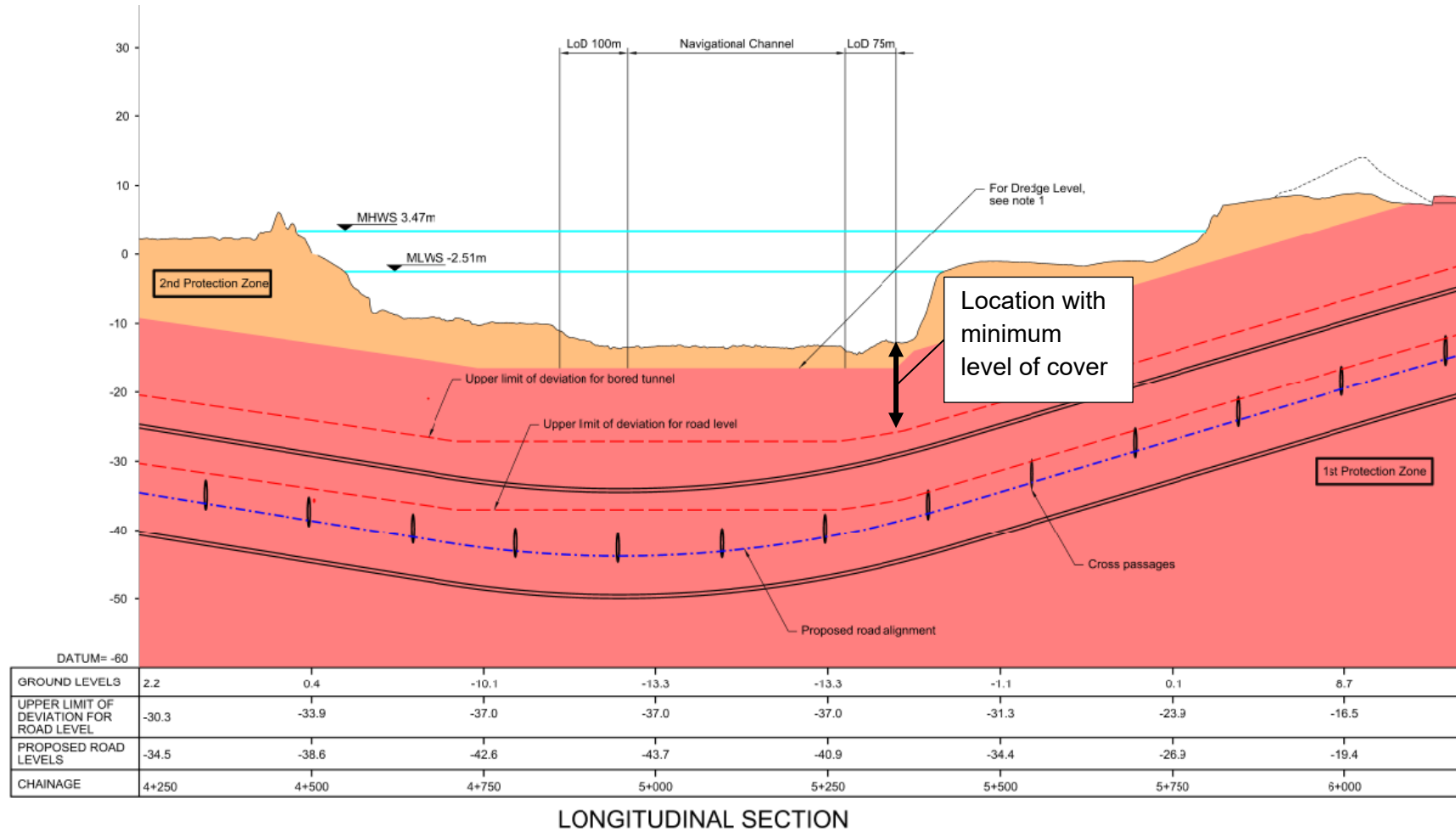

Table 3.1 Levels of cover

| Section | Scenario | Description | Riverbed level | Level of cover at minimum cover location |
|----------------------|---|---|----------------------------|--|
| CS1 | Reference design | The case is the baseline, current alignment and assumed riverbed level. | -12.70m AOD (-9.6m CD) | 15.9m (0.99D) |
| CS2 | Future dredge/future riverbed level | Agreed dredge level, including over dredge | -16.12m AOD (-13.0m CD) | 12.6m (0.79D) |
| CS3 | Theoretical lowest riverbed level | Dredged level with further riverbed lowering to accommodate 0.5m scour protection | -16.62m AOD (-13.5m CD) | 12.1m (0.75D) |
| CS4 | Maximum LOD and current riverbed level | Tunnel crown at the highest level permissible (top LOD) and assumed current riverbed level. | -12.70m AOD (-9.6m CD) | 13.0m (0.81D) |
| CS5 | Maximum LOD and agreed future dredge/ future riverbed level | Tunnel crown at the highest level permissible (top LOD) and riverbed at agreed dredge level, including over dredge | -16.12m AOD (-13.0m CD) | 9.6m (0.6D) |
| CS6 | Maximum LOD and theoretical lowest riverbed level | Tunnel crown at the highest level permissible (top LOD) and riverbed at dredged level with further riverbed lowering to accommodate 0.5m scour protection | -16.62m AOD (-13.5m CD) | 9.1m (0.57D) |
| Additional Section 1 | Maximum LOD and theoretical lowest riverbed level with precautionary scour protection | Tunnel crown at the highest level permissible (top LOD) and riverbed at dredged level with further riverbed lowering to accommodate 1.3m precautionary scour protection | -17.42m AOD (-14.3m CD) | 8.3m (0.52D) |

4 Implications on assessments

The implications of a potential level of cover over the tunnel of 0.52D have been considered for each identified area of concern.

4.1 Flotation

4.1.1 The risk of flotation of the tunnel has been considered, and it is concluded that the tunnel is stable for all scenarios, including the current riverbed level, the prospective future riverbed level agreed with the PLA, and for a precautionary scenario where additional dredging is required to install scour protection.

4.1.2 The analysis setting out this assessment is included as Appendix A.

4.2 Assessment of reasonable alternatives

4.2.1 Table 3.15 of ES Chapter 3: Assessment of Reasonable Alternatives [[APP-141](#)] indicates that the minimum cover to the tunnel under the River Thames was reduced to 1.0 times the outer diameter of the tunnel. This assessment demonstrates alternatives considered, and is unaffected by a different level of cover over the tunnel.

4.2.2 The Applicant does not consider it necessary to amend or update the relevant Application Document.

4.3 Marine biodiversity

4.3.1 The wording of ES Chapter 9: Marine Biodiversity [[APP-147](#)] indicated a layer of cover of at least 0.9 times the tunnel diameter, before this was amended by the ES Addendum [[REP5-062](#)].

4.3.2 A review has been completed of the analysis reported in ES Appendix 9.1: Assessment of Ground-Borne Noise and Vibration, and Underwater Noise from the Tunnel Boring Machine at Marine Receptors [[APP-420](#)]. This review concluded that a reduction in the level of cover to 0.57D would not result in any materially new or materially different impacts and therefore would not change the conclusions of the assessment set out in ES Chapter 9: Marine Biodiversity [[APP-147](#)]. The revised minimum level of 0.52D would not apply, as any dredging for scour protection would not take place at the same time as the tunnel was being constructed.

4.3.3 The Applicant considers that the amendment made by the ES Addendum [[REP5-062](#)] is appropriate to address this matter.

5 Implications on the draft DCO

5.1 Drafting at Deadline 3

- 5.1.1 This section was prepared for the Deadline 3 submission of this document. The text has been left as a record, but is superseded by the later drafting sections.
- 5.1.2 Article 33 of the draft DCO [REP3-077] sets out the rights to acquire subsoil. Extracts from the drafting are provided below:

'Acquisition of subsoil or airspace only

33.—(1) The undertaker may acquire compulsorily so much of, or such rights in, the subsoil of or of the airspace over the land referred to in paragraph (1) of article 25 (compulsory acquisition of land) as may be required for any purpose for which that land may be acquired under that provision instead of acquiring the whole of the land.

[...]

(6) References in paragraph (2)(a) to subsoil are references to the subsoil lying at and below the depths specified in column (2) of Schedule 10 beneath the level of the surface of the land, and references to the remaining subsoil in paragraph (2)(b) are references to the part of the subsoil lying above the shallowest part of the subsoil acquired under paragraph (2)(a) but below the level of the surface of the land.

(7) For the purposes of paragraph (6) "the level of the surface of the land" means—

- (a) in the case of any land on which a building is erected, the level of the surface of the ground adjoining the building;*
 - (b) in the case of a river, dock, canal, navigation, watercourse or other water area, the level of the surface of the ground covered by water; or*
 - (c) in any other case, ground surface level,*
- at the time of this Order coming into force.'*

5.2 Proposed amendments to the draft DCO

- 5.2.1 This text sets out amendments to the draft DCO that were proposed at Deadline 3 and implemented at Deadline 5. The text has been left as a record, but is superseded by the later drafting sections.
- 5.2.2 The Applicant acknowledges the position of the PLA, that if the depth of the navigable channel were to change prior to the DCO coming into force, there would be a resultant impact on the ability to acquire subsoil, and that this could lead to the Applicant being unable to acquire subsoil at the level required.
- 5.2.3 In addition, the Applicant recognises that as the level of the riverbed varies across a land plot, the PLA could consider there could be ambiguity over the relevant depth to be considered when determining the acquisition of subsoil. For the avoidance of doubt, the Applicant considered the average level of the riverbed across the plot as a datum for that plot when determining the depth of

subsoil set out in Schedule 10, and set the upper level of the subsoil to be required at the highest elevation of the upper LOD for the tunnel within that plot.

5.2.4 In order to provide the PLA with further certainty and assurance, the Applicant is currently considering redrafting this aspect of the draft DCO.

5.2.5 The Applicant is reviewing a modification to article 33(7) to fix the datum for determining the depth of subsoil under the River Thames as Ordnance Datum Newlyn (a change from riverbed level). This amendment allows for better clarity over the depth of subsoil to be required, regardless of the variability of the riverbed level across the plot, and certainty that any changes to the riverbed level in advance of the DCO coming into force will not result in changes to the rights to acquire subsoil.

5.2.6 The proposed redrafted article 33(7) would be as follows:

'(7) For the purposes of paragraph (6) and Schedule 10 "the level of the surface of the land" means–

(a) in the case of any land on which a building is erected, the level of the surface of the ground adjoining the building;

(b) in the case of a river (except where paragraph (c) applies), dock, canal, navigation, watercourse or other water area, the level of the surface of the ground covered by water;

(c) in the case of plots 15-10, 15-11, 15-12, 16-42, and 16-43, the level of Ordnance Datum Newlyn;

(d) in any other case, ground surface level,

at the time of this Order coming into force.'

5.2.7 The Applicant is currently engaging with the PLA on this drafting, as well as other parties identified in the Book of Reference [[REP5-030](#)] that have interests on the relevant plots.

5.2.8 As a consequence of this amendment, the Applicant will need to update column 2 of Schedule 10 of the draft DCO to reflect the change in datum, with respect to plots 15-10, 15-11, 15-12, 16-42, and 16-43.

5.3 Deadline 7 Update

5.3.1 The original version of the Tunnel Depth Report was submitted at Deadline 3, following which the changes set out above were made at Deadline 5. Further discussions with the PLA have led to further refinements which have been incorporated in the draft DCO submitted at Deadline 6 [[REP6-010](#)].

5.4 Provisions of the draft DCO

5.4.1 Paragraph 98(1) of Schedule 14 (the Protective Provisions for the PLA) provides for the approval of any specified work, excluding any tunnelling works forming part of a specified work. Because of the specific nature of the tunnelling works, a more comprehensive and specific approach is taken to provision of information in relation to the design and construction methodology, including the management of any dispute over the proposed works.

- 5.4.2 Paragraph 99(1) of Schedule 14 (the Protective Provisions for the PLA) contains a requirement for the tunnels to be constructed and operated in accordance with the depths agreed with the PLA. These depths take precedence over the LOD, and must always be adhered to. Prior to the commencement of the tunnelling works, the PLA’s protective provisions would require a submission of details confirming this design requirement is met. The PLA also has a robust set of protective provisions which requires approvals in connection with “specified works” which is defined as:
- ‘any part of the authorised development (which for this purpose includes the removal of any part of the authorised development), which—*
- (a) is, may be, or takes place in, on, under or over the surface of land below the level of mean high water forming part of the river Thames; or*
 - (b) may affect the river Thames or any function of the PLA’*
- 5.4.3 Within paragraph 99 (3) and (4) the PLA have the ability to request representation by the Applicant on aspects of the design and construction of the tunnel that the PLA feels do not protect paragraph 99(1)(b) and if still disputed, routes to resolve the matter.
- 5.4.4 Paragraph 100 provides further requirements in relation to provision of information to the PLA relating to the construction of the tunnelling works.
- 5.4.5 The PLA, at Deadline 1, requested a modification to the Tunnel Limits of Deviation Plans [[REP4-074](#)] in the river section. Through ongoing discussions with the PLA, it has been agreed the requested modifications are not necessary.

6 Implications on Statement of Reasons

6.1 Basis of the protection zone

- 6.1.1 Section 5.4 of the Statement of Reasons [REP5-028] sets out the basis for the development of the protection zones set out in the River Restrictions Plan [REP1-041]. The basis is illustrated by Plate 6.1, which is reproduced below.

Plate 6.1 Illustrative cross-section showing the zone of protection and exclusion zone

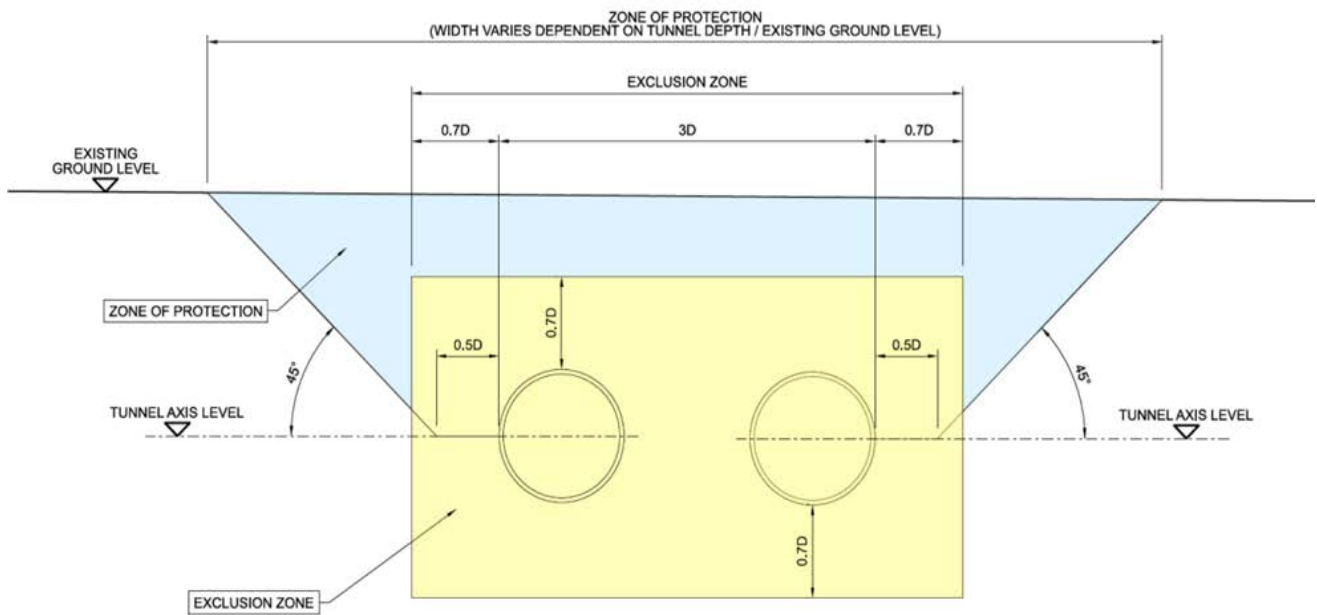

- 6.1.2 The Applicant acknowledges that at certain points along the tunnel profile, notably the point with minimum level of cover identified in Plate 3.1, the level of cover will be less than the 0.7D set out as the basis for the first protection zone (the exclusion zone) and that in certain locations, in the event that the riverbed is lowered, there may not be a second protection zone. The Applicant is satisfied that, considering the flotation analysis referenced in Section 4.1, and the nature of the geology in this location, that the protections and controls set out in the River Restrictions Plan [REP1-041] are robust and sufficient.
- 6.1.3 As the plate within the Statement of Reasons is illustrative and does not define the requirements, which are set out in the draft DCO [REP5-024] and secured documents, it is not considered necessary to update this document.

References

UK Parliament (2023). Transport Update: Statement made on 9 March 2023, Statement UIN HCWS625. Accessed August 2023. <https://questions-statements.parliament.uk/written-statements/detail/2023-03-09/hcws625>.

Glossary

| Term | Abbreviation | Explanation |
|--|------------------------|--|
| A122 | | The new A122 trunk road to be constructed as part of the Lower Thames Crossing project, including links, as defined in Part 2, Schedule 5 (Classification of Roads) in the draft DCO (Application Document 3.1) |
| A122 Lower Thames Crossing | Project | A proposed new crossing of the Thames Estuary linking the county of Kent with the county of Essex, at or east of the existing Dartford Crossing. |
| Above ordnance datum | AOD | Vertical datum used by the Ordnance Survey as the basis for deriving altitudes on maps. |
| Application Document | | In the context of the Project, a document submitted to the Planning Inspectorate as part of the application for development consent. |
| Chart Datum | CD | Chart Datum is unique to each location and is usually set to be close to the lowest astronomical tide level that can occur under normal meteorological conditions. The Tilbury Chart Datum is -3.12 mAOD |
| Construction | | Activity on and/or offsite required to implement the Project. The construction phase is considered to commence with the first activity on site (e.g. creation of site access), and ends with demobilisation. |
| Development Consent Order | DCO | Means of obtaining permission for developments categorised as Nationally Significant Infrastructure Projects (NSIP) under the Planning Act 2008. |
| Development Consent Order application | DCO application | The Project Application Documents, collectively known as the 'DCO application'. |
| Environmental Statement | ES | A document produced to support an application for development consent that is subject to Environmental Impact Assessment (EIA), which sets out the likely impacts on the environment arising from the proposed development. |
| Limits of deviation | LOD | The tolerances, both laterally and vertically, that any parts of the Project can be constructed from the lines and situations shown on the Works Plans (Application Document 2.6) and the levels shown on the Engineering Section Drawings (Application Document 2.9). |
| National Highways | | A UK government-owned company with responsibility for managing the motorways and major roads in England. Formerly known as Highways England. |
| metres Above Ordnance Datum | mAOD | The Ordnance Datum is the basis for all the land heights that appear on Ordnance Survey maps. It is essentially the mean sea level at Newlyn in Cornwall, and is sometimes called Ordnance Datum Newlyn (ODN). |
| Operation | | Describes the operational phase of a completed development and is considered to commence at the end of the construction phase, after demobilisation. |
| Ordnance datum | | A standardised point representing average (mean) sea level, used by the Ordnance Survey as the basis for measurement of height (altitude) on UK maps, reported as metres 'Above Ordnance Datum' |

| Term | Abbreviation | Explanation |
|---------------------------------|--------------|---|
| Port of London Authority | PLA | A self-funding public trust established by The Port of London Act 1908 to govern the Port of London. Its responsibility extends over the Tideway of the River Thames and its continuation (the Kent/Essex strait). It maintains and supervises navigation, and protects the river's environment. |
| Project road | | The new A122 trunk road, the improved A2 trunk road, and the improved M25 and M2 special roads, as defined in Parts 1 and 2, Schedule 5 (Classification of Roads) in the draft DCO (Application Document 3.1). |
| Project route | | The horizontal and vertical alignment taken by the Project road. |
| South Portal | | The South Portal of the Project (southern tunnel entrance) would be located to the south-east of the village of Chalk. Emergency access and vehicle turn-around facilities would be provided at the tunnel portal. The tunnel portal structures would accommodate service buildings for control operations, mechanical and electrical equipment, drainage and maintenance operations. |
| The tunnel | | Proposed 4.25km (2.5 miles) road tunnel beneath the River Thames, comprising two bores, one for northbound traffic and one for southbound traffic. Cross-passages connecting each bore would be provided for emergency incident response and tunnel user evacuation. Tunnel portal structures would accommodate service buildings for control operations, mechanical and electrical equipment, drainage and maintenance operations. Emergency access and vehicle turn-around facilities would also be provided at the tunnel portals. |
| Tunnel Diameter | D | The external diameter of one of the road tunnels, including the concrete segments. |

Appendix A Flotation sensitivity check to satisfy future riverbed levels

A.1 Executive Summary

A.1.1 As part of the discussions with the Port of London Authority (PLA), a flotation sensitivity analysis for the main tunnels was carried out on the future provisions with the reference design. Paragraph 99(1) of the Protective Provisions for the benefit of the PLA (in Schedule 14 of the draft Development Consent Order (DCO) [REP5-024]) secures future dredging by the PLA to the potential future dredge level of -12.5m chart datum (CD) (-15.62m above ordnance datum (AOD)) plus the additional allowance for 0.5m over-dredging, which would give a potential future riverbed level of -13.0m CD. The dredging has been agreed across a 475m navigational channel of the River Thames (see the River Restrictions Plan [REP1-041]). These depths take precedence over the limits of deviation (LOD) for the tunnels (as shown in the Tunnel Limits of Deviation Plans [REP4-074]) as per article 6 of the draft DCO.

A.1.2 Sensitivity analyses have been undertaken to assess the stability of a single tunnel bore due to possible flotation at the shallowest level, which is on the northern boundary of the navigational channel adjacent to Diver Shoal (see Annex A). The tunnel has been assessed at both the vertical alignment proposed in the reference design for the DCO and the upper LOD being sought in the DCO. These two tunnel levels were investigated for various riverbed level scenarios:

- a. current riverbed level
- b. agreed dredge level (-16.12m AOD (-13m CD))
- c. agreed dredge level with provision for scour protection -16.62m AOD (-13.5m CD) (if scour protection was needed, 0.5m thick and dredging to allow its insertion). Note: National Highways does not propose scour protection and does not consider it is necessary, but the analysis has been undertaken to provide comfort that the design of the tunnel, within the agreed dredging levels, is feasible.

A.1.3 Each scenario is based on the current tunnel alignment (reference design) as well as the upper LOD. The analysis is intended to demonstrate that the range of potential tunnel alignments under consideration are satisfactory.

- A.1.4 The tunnel below the River Thames is situated in Chalk, which has appropriate shear strength, so this flotation analysis considers some shear strength within the soil. The flotation calculations satisfy the stability criteria for all tunnel horizons and riverbed levels. This analysis shows there is no impediment to the agreed dredging levels being secured. If development consent is granted, detailed plans would be submitted to the PLA in connection with the tunnelling works (as per paragraph 98 of Schedule 14 of the draft DCO [\[REP5-024\]](#)).

A.2 Introduction

- A.2.1 Since the completion of the reference design, the Statement of Common Ground with the Port of London Authority (PLA) [APP-100] has been progressed. National Highways has agreed with the PLA the limits of the navigational channel (75m to the north and 100m to the south) and the right for the PLA to dredge to -12.5m chart datum (CD) (-15.62m AOD). In addition, an allowance for another 0.5m of over-dredging is contained in article 99(1) of Schedule 14 to the draft DCO [\[REP5-024\]](#) and reflected in the River Restrictions Plan [\[REP1-041\]](#).
- A.2.2 Out of these discussions with PLA, it was considered necessary by the PLA to undertake sensitivity analyses to assess the depth to which the riverbed could be lowered and not require scour protection or ballasting. PLA are concerned that post-dredging of the navigational channel and any further natural deepening of the river that might occur, may need additional scour protection to protect the tunnels and this might in turn reduce the available depth for the navigational channel.
- A.2.3 Sensitivity checks have been carried out on a single tunnel to assess the current vertical and horizontal alignment and the tunnel limits of deviation (LOD) against a future riverbed level of -13m CD (-12.5m dredge plus 0.5m over-dredge allowance). A likely thickness of scour protection was also calculated and an additional depth allowed for the installation of such protection without impeding the navigational channel.
- A.2.4 The scour protection assessment considered previous analysis on the current riverbed stability of the River Thames carried out by National Highways. This analysis had concluded that the riverbed was stable with very little shift in depth. Despite this conclusion, a precautionary sensitivity analysis has also been carried out in relation to a theoretical scour protection by taking the dredged depth of the river and river flow rates from the Tilbury2 DCO application (Port of Tilbury London Limited , 2017) and calculating the required particle size of scour protection and the required thickness. This was calculated to be 0.5m thick with a D_{n50} grading of 0.034m.

- A.2.5 The LOD have been included in the DCO to allow flexibility to optimise the detailed design and to allow for construction tolerances. This enables the detailed designer to ensure that the safest, most sustainable, and lowest carbon solution can be delivered. Considerations during detailed design will include both the construction and the long-term operation of the asset, which is designed with a 120-year design life. The detailed design will also consider how the vertical alignment would influence vehicle braking (risk of fire, brake failure), the amount of climbing on exiting (reducing fuel and air quality impacts), and also construction considerations such as minimising the requirements for hyperbaric working. In addition to these factors, any solution would also be required to comply with all aspects of the DCO, including the agreed dredging levels.
- A.2.6 The PLA requested a modification to the Tunnel Limits of Deviation Plans [\[REP4-074\]](#) at Deadline 1. Through engagement between Deadline 1 and Deadline 6, it has been agreed with the PLA that no modifications are required in the river section.
- A.2.7 The Applicant did not consider this necessary given the LOD take effect subject to the agreed depths, and the flexibility (which could be met without affecting those depths) is required. In particular, the Applicant noted that there may be changes to construction methodology or design which would enable the utilisation of the LOD without affecting the agreed and legally binding tunnelling depths. This protection is further reinforced by the Protective Provisions for the PLA in Schedule 14 to the draft DCO [\[REP5-024\]](#), which are set out in Section 5.3 in the body of the main report.

A.3 Flotation assessment

Analysis

- A.3.1 The flotation check was carried out at one section at the northern edge of the navigational channel LOD near the toe of Diver Shoal, see Plate A.1 (extract) and Annex A (full drawing section). This location was selected as it is where flotation risk is likely to be the greatest. The analysis is therefore necessarily based on a reasonable worst-case scenario. Three riverbed levels were used for the assessment. Six tunnel cross-sections were analysed and are detailed in Table A.1.

Plate A.1 Assessed tunnel section

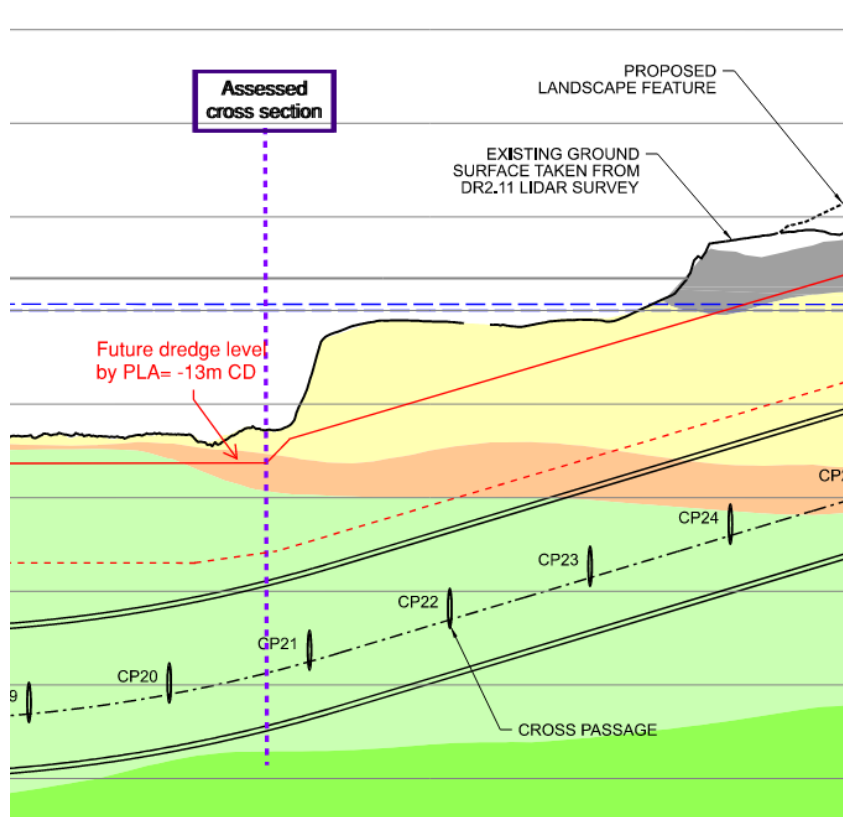

Table A.1 Analysis sections considered for flotation assessment

| Analysis Section No. | Section | Riverbed level | Description |
|----------------------|---|----------------------------|--|
| CS1 | Reference design | -12.70m AOD (-9.6m CD) | The case is the baseline, current alignment and assumed riverbed level. |
| CS2 | Reference design and agreed future dredge/future riverbed level | -16.12m AOD (-13.0m CD) | Agreed dredge level, including over dredge |
| CS3 | Reference design and theoretical lowest riverbed level | -16.62m AOD (-13.5m CD) | Dredged level with further riverbed lowering that requires scour protection |
| CS4 | Maximum upward LOD and current riverbed level | -12.70m AOD (-9.6m CD) | Tunnel crown at the highest level permissible (upward LOD) and assumed current riverbed level. |
| CS5 | Maximum upward LOD and agreed future dredge/future riverbed level | -16.12m AOD (-13.0m CD) | Tunnel crown at the highest level permissible (upward LOD) and riverbed at agreed dredge level, including over dredge |
| CS6 | Maximum upward LOD and theoretical lowest riverbed level | -16.62m AOD (-13.5m CD) | Tunnel crown at the highest level permissible (upward LOD) and riverbed at dredged level with further riverbed lowering that requires scour protection |

A.3.2 For the analyses, lower bound values for the soil properties were used from the Project boreholes in the region of the analysed section. The selection of lower bound values has provided a conservative basis for the design at this stage of the Project and optimisation could occur at detailed design using median values. The analysis is therefore a reasonable worst-case scenario, and which may be refined in detailed design.

A.3.3 The tunnel and ground levels (for the riverbed) are shown below in Table A.2.

Table A.2 Section levels

| Analysis Section No. | Cover (m) | Ratio of cover to diameter | Riverbed level (m AOD) | Tunnel Axis (m AOD) | Groundwater level (m AOD) |
|----------------------|-----------|----------------------------|------------------------|---------------------|---------------------------|
| CS1 | 15.9 | 0.99D | -12.70 | -36.7 | 6.83 |
| CS2 | 12.6 | 0.79D | -16.12 | -36.7 | 6.83 |
| CS3 | 12.1 | 0.75D | -16.62 | -36.7 | 6.83 |
| CS4 | 13.0 | 0.81D | -12.70 | -33.7 | 6.83 |
| CS5 | 9.6 | 0.60D | -16.12 | -33.7 | 6.83 |
| CS6 | 9.1 | 0.57D | -16.62 | -33.7 | 6.83 |

A.3.4 For CS3, a high-level study was undertaken to determine the likely required thickness for scour protection, if required. This used the river channel flow speeds from the Tilbury2 DCO application (Port of Tilbury London Limited, 2017) and calculating the required particle size of scour protection and the required thickness. This was calculated to be 0.5m thick with a D_{n50} grading of 0.034m.

A.4 Methodology

A.4.1 Table A.1 and Plate A.2 above outline the various analysis sections considered. Within each analysis section, the following assessments were undertaken.

A.4.2 The tunnel was checked for flotation using Design Codes & Standards BS EN 1997-1:2004+A1:2013 Eurocode 7 Geotechnical design (British Standards Institution, 2013) and NA+A2:2022 to BS EN 1997-1:2004+A1:2013 UK National Annex to Eurocode 7 (British Standards Institution, 2022).

A.4.3 Various design cases can be applied when assessing the stability of a tunnel due to flotation. This analysis has considered the following design case of allowing for shear resistance in the soil column above the tunnel axis. The design case for no shear was not considered when assessing the tunnels resistance to flotation, because the tunnel's vertical alignment would place it in Chalk below the river. Therefore, discussion regarding compliance to a no shear design case can be considered too conservative.

- A.4.4 In addition to the stabilising soil forces of the soil column and tunnel lining, full shear along the vertical boundary is taken into account in the design case. The average level of shear resistance along the vertical planes was taken as a conservative value for the geology above the tunnel axis. The case also considers either the effects of EC7 material partial factors in calculating the resistance or a favourable partial factor on the effect of the resistance using unfactored parameters.

Plate A.2 Shear design case

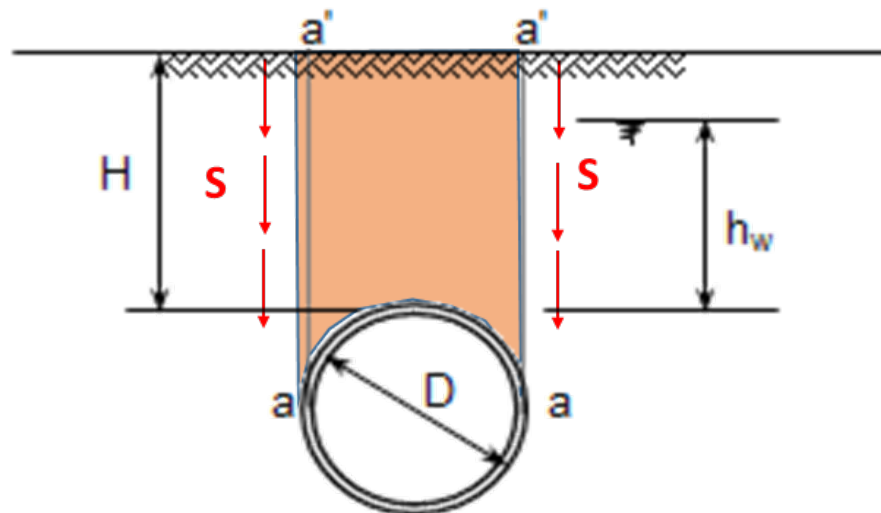

- A.4.5 The flotation assessment also considered the temporary construction stage (i.e., no internal structure). Due to the river setting and the water level being above that of the soil surface, the effect of water level is not critical; however, for simplicity, the long-term flood level (6.83m AOD, 1 in 1,000-year return period) was used.
- A.4.6 Due to the assessment looking at potential future scenarios that may affect the stability of the tunnel, only the worst loading cases within the tunnel have been assessed without the benefit of accidental load factors. Again, this shows how this analysis represents a worst-case scenario. Any future changes in riverbed depth are likely to occur after construction, where there would be an additional benefit from the internal structural elements (circa 250-350kN/m), road surfacing and MEICA installed in the tunnel. However, in the tunnel's lifespan, a complete retrofit may be required, and understanding if this would be possible without the need for mitigation methods is useful to provide full flexibility for the tunnel operator.
- A.4.7 The calculations are carried out following BS EN 1997-1 (British Standards Institution, 2013).

A.5 Results

A.5.1 The analysis has been undertaken to see the sensitivity of the tunnels to riverbed and tunnel level when utilising lower bound (conservative) soil properties. Table A.3 shows the flotation results for each analysed section when considering an allowance for shear in the soil column above the tunnel (this is reasonable on the basis that a ‘no shear’ protection is infeasible given the presence of Chalk in the river). At detailed design, the parameters can be optimised, but even utilising these conservative assumptions, the results show the tunnels ‘passing’ in all scenarios.

Table A.3 Flotation results

| Analysis Section No. | Results |
|----------------------|---------|
| CS1 | Pass |
| CS2 | Pass |
| CS3 | Pass |
| CS4 | Pass |
| CS5 | Pass |
| CS6 | Pass |

A.6 Discussion

- A.6.1 Resistance against flotation passes for all three riverbed levels when shear is accounted for in resisting uplift, for both the tunnel reference design and the upper LOD alignments.
- A.6.2 When checking the tunnel alignment using the Project’s maximum LOD with the three riverbed levels, the resistance against flotation is unsurprisingly lower. For cases where shear is allowed for, the scenario passes.
- A.6.3 For all load cases, the lower bound value for bulk unit weight was considered, and permanent load factors were used. These assessments are therefore considered conservative, with the addition that no internal structural weight was considered for any of the load cases. For all scenarios, but particularly the dredged navigational channel (CS2) scenario and additional riverbed lowering (CS3), the inclusion of 250kPa for the internal structure based on the reference design would provide a significant increase beneficial loading to prevent flotation.
- A.6.4 Given the time spans of construction in relation to when a future deeper channel might be dredged, it can be assumed that for CS2, CS3, CS5 and CS6 the internal structures could be utilised as a beneficial load at detailed design. This will require confirmation at the detailed design stage and prior to construction through consultation with the PLA as the baseline may change.

- A.6.5 Additionally, it should be noted that for the riverbed to lower to the level in CS3 and CS6 (-16.62m AOD) it would require the erosion of the River Terrace Deposits at the point of lowest tunnel cover (Chalk elsewhere). Given the current flow rates of the river and stability of the Alluvium deposits, this would be considered unlikely to occur and, hence, levels used for CS3 and CS6 are conservative.

A.7 Conclusion

- A.7.1 From the assessment above it can be concluded that, based on the reference design tunnel alignment, the stability of the tunnel can be satisfied for both the agreed future dredge levels, and there is adequate cover to allow for scour protection without impacting the future dredge levels across the width of the navigational channel.
- A.7.2 The assessment also demonstrates, with conservative assumptions, that valid design solutions exist within the full range of the LODs in the draft DCO [\[REP5-024\]](#). The proposed final alignment will be within the range of the LODs and will require thorough analysis at the detailed design stage to confirm that it can be safely constructed and maintained and does not contradict the requirements of paragraph 99(1) in Part 8 of Schedule 14 of the draft DCO [\[REP5-024\]](#).

Appendix B Flotation report update: scour protection allowance

B.1 Introduction

B.1.1 Following on from Deadline 4 and the Tunnels Issue Specific Hearing (ISH5) comments and queries from the Port of London Authority (PLA), the Applicant has taken onboard the specific comments regarding the Flotation sensitivity check at Appendix A of this document relating to the thickness and particle sizing of any potential scour protection.

B.2 Update

- B.2.1 The PLA raised concerns over the allowed thickness for future scour protection and the grading size of the stone suggested as an option. The concern was around whether it would be stable with the action of large vessel propeller forces acting on it as they passed over. The Applicant has undertaken the additional work, even though it believes that, given the resulting geology and the current stability of the riverbed, future scour protection will not be required for erosion by natural means or the action of large vessel propellers.
- B.2.2 As set out in Annex B, the Applicant has undertaken a conservative assessment on the potential thickness of scour protection using the data from a 330m-long vessel with a 14m draught. The size and navigating speed match those suggested by the PLA through specific correspondence. Conservative values were used for both the ship speed and tidal speed to ensure that there is future flexibility in any proposed scour protection. The solution assessed a rock-based method of protecting the riverbed; other matting-based methods could be used and would reduce the required thickness.
- B.2.3 The analysis calculated a 0.8m thick layer of rock protection using 60-300kg rocks (DN50= 0.41m). Additionally, a 0.5m filter layer was also included, again, this has the possibility of being omitted in the future, based on the underlying geology, or utilising a weighted geotextile matting to avoid upwards movement of fines under the rock layer. The new thickness taken forward for the reduced cover in the flotation note was 1.3m. It is believed that, if required, the original thickness of 0.5m could be achieved if a detailed design was necessary.
- B.2.4 For the flotation calculations, case CS6 was modified to reflect the changes (and renamed to “Additional section 1”), and re-run with the new potential riverbed level of -17.42m AOD. The tunnel still passed under the flotation criteria. This addresses the PLA's concern regarding the thickness of the scour protection and the stability of the tunnel due to flotation, even when the maximum Limits of Deviation are utilised.

References

British Standards Institution (2013). BS EN 1997-1:2004+A1:2013 Eurocode 7. Geotechnical design – General rules.

British Standards Institution (2022). NA+A2:2022 to BS EN 1997-1:2004+A1:2013 UK National Annex to Eurocode 7. Geotechnical design – General rules.

Port of Tilbury London Limited (2017). Proposed Port Terminal at Former Tilbury Power Station, Tilbury2, TR030003, Environmental Statement Appendix 16.D: Hydrodynamic Sediment Modelling. Accessed May 2023.

<https://infrastructure.planninginspectorate.gov.uk/projects/south-east/tilbury2/?ipcsection=docs&stage=app&filter1=Environmental+Statement>.

Glossary

| Term | Abbreviation | Explanation |
|--|------------------------|--|
| A122 | | The new A122 trunk road to be constructed as part of the Lower Thames Crossing project, including links, as defined in Part 2, Schedule 5 (Classification of Roads) in the draft DCO (Application Document 3.1) |
| A122 Lower Thames Crossing | Project | A proposed new crossing of the Thames Estuary linking the county of Kent with the county of Essex, at or east of the existing Dartford Crossing. |
| Above ordnance datum | AOD | Vertical datum used by the Ordnance Survey as the basis for deriving altitudes on maps. |
| Application Document | | In the context of the Project, a document submitted to the Planning Inspectorate as part of the application for development consent. |
| Chart Datum | CD | Chart Datum is unique to each location and is usually set to be close to the lowest astronomical tide level that can occur under normal meteorological conditions. The Tilbury Chart Datum is -3.12m AOD. |
| Construction | | Activity on and/or offsite required to implement the Project. The construction phase is considered to commence with the first activity on site (e.g. creation of site access), and ends with demobilisation. |
| Development Consent Order | DCO | Means of obtaining permission for developments categorised as Nationally Significant Infrastructure Projects (NSIP) under the Planning Act 2008. |
| Development Consent Order application | DCO application | The Project Application Documents, collectively known as the 'DCO application'. |
| D_{n50} | | D _{n50} is the nominal stone diameter for the median armourstone size for grading (m). |
| Environmental Statement | ES | A document produced to support an application for development consent that is subject to Environmental Impact Assessment (EIA), which sets out the likely impacts on the environment arising from the proposed development. |
| Limits of deviation | LOD | The tolerances, both laterally and vertically, that any parts of the Project can be constructed from the lines and situations shown on the Works Plans (Application Document 2.6) and the levels shown on the Engineering Section Drawings (Application Document 2.9). |
| National Highways | | A UK government-owned company with responsibility for managing the motorways and major roads in England. Formerly known as Highways England. |
| metres Above Ordnance Datum | M AOD | The Ordnance Datum is the basis for all the land heights that appear on Ordnance Survey maps. It is essentially the mean sea level at Newlyn in Cornwall, and is sometimes called Ordnance Datum Newlyn (ODN). |
| Operation | | Describes the operational phase of a completed development and is considered to commence at the end of the construction phase, after demobilisation. |
| Ordnance datum | | A standardised point representing average (mean) sea level, used by the Ordnance Survey as the basis for measurement of height (altitude) on UK maps, reported as metres 'Above Ordnance Datum' |

| Term | Abbreviation | Explanation |
|---------------------------------|--------------|---|
| Port of London Authority | PLA | A self-funding public trust established by The Port of London Act 1908 to govern the Port of London. Its responsibility extends over the Tideway of the River Thames and its continuation (the Kent/Essex strait). It maintains and supervises navigation, and protects the river's environment. |
| Project road | | The new A122 trunk road, the improved A2 trunk road, and the improved M25 and M2 special roads, as defined in Parts 1 and 2, Schedule 5 (Classification of Roads) in the draft DCO (Application Document 3.1). |
| Project route | | The horizontal and vertical alignment taken by the Project road. |
| The tunnel | | Proposed 4.25km (2.5 miles) road tunnel beneath the River Thames, comprising two bores, one for northbound traffic and one for southbound traffic. Cross-passages connecting each bore would be provided for emergency incident response and tunnel user evacuation. Tunnel portal structures would accommodate service buildings for control operations, mechanical and electrical equipment, drainage and maintenance operations. Emergency access and vehicle turn-around facilities would also be provided at the tunnel portals. |
| Tunnel Diameter | D | The external diameter of one of the road tunnels, including the concrete segments. |

Annexes

Annex A Tunnel profile and geological section

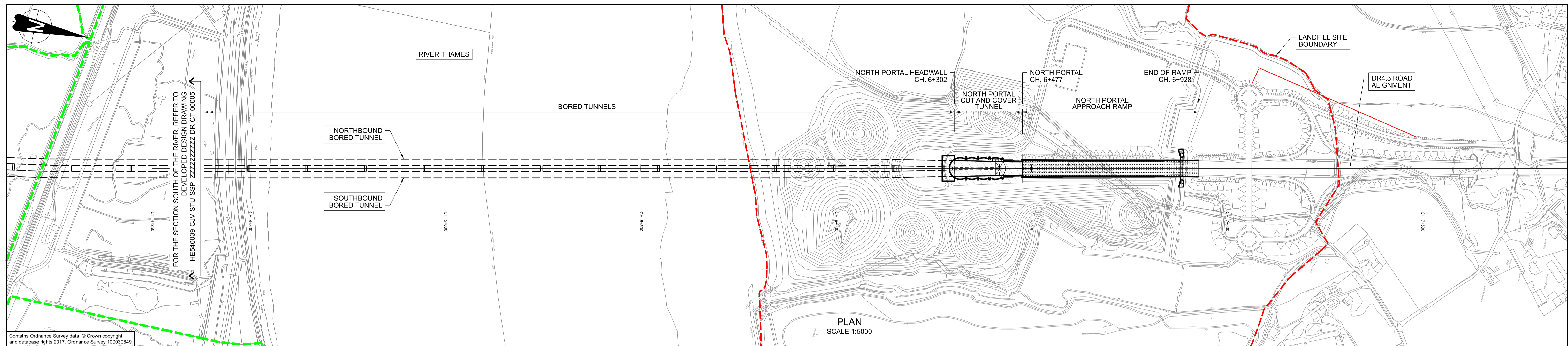

Contains Ordnance Survey data. © Crown copyright and database rights 2017. Ordnance Survey 100030649

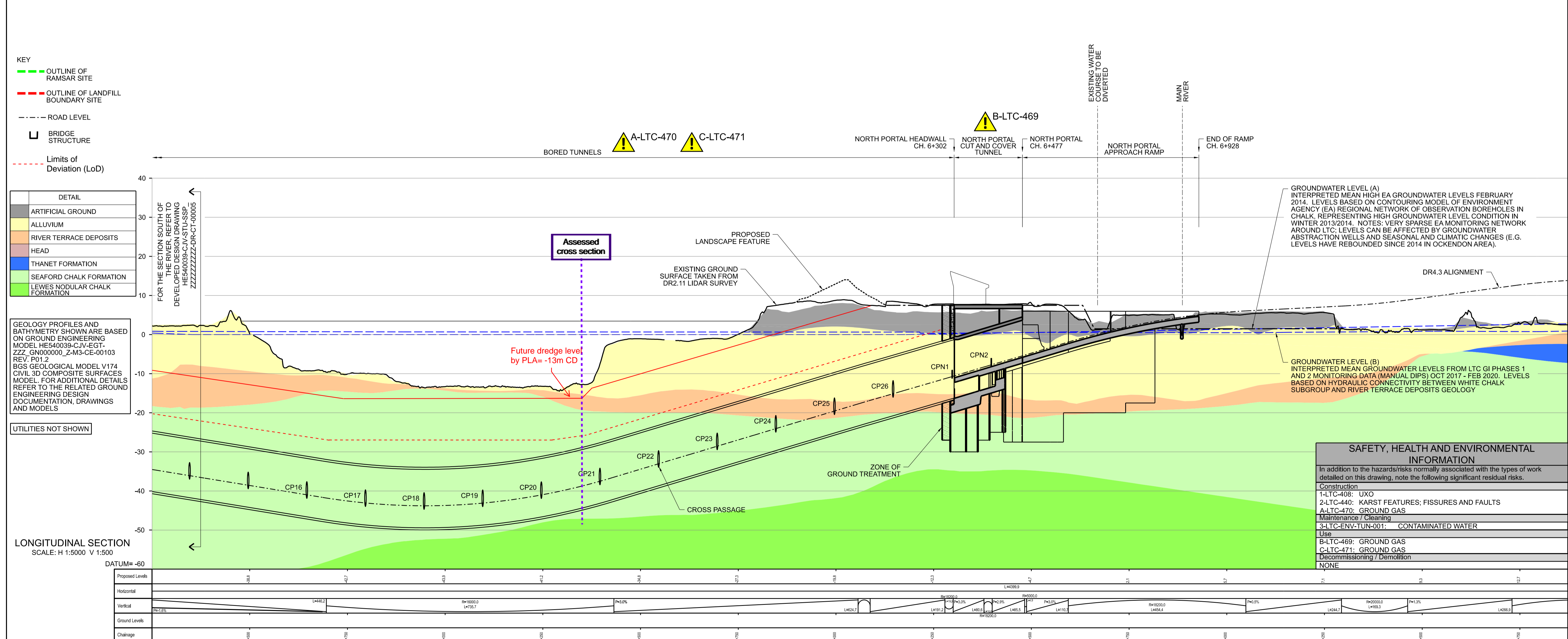

| Rev | Status | Rev. Date | Purpose of revision | Drawn | Chk'd | Appr'd |
|-----|--------|------------|---------------------|-------|-------|--------|
| P01 | S2 | 05/04/2022 | DESIGN RELEASE 4.3 | RT | NP | JBG |

NOTES:

1. ALL DIMENSIONS IN MILLIMETRES AND ALL LEVELS IN METRES UNLESS SHOWN OTHERWISE.
2. ALL LEVELS ARE IN METRES AND RELATE TO ORDNANCE DATUM UNLESS STATED OTHERWISE.
3. DO NOT SCALE FROM THIS DRAWING. DO NOT TAKE DIGITAL DIMENSIONS OFF THIS DRAWING. WORK TO FIGURED DIMENSIONS ONLY - IF IN DOUBT ASK.
4. CHAINAGES AND LEVELS SHOWN ON THE LONGITUDINAL SECTION ARE FOR THE NORTHBOUND ALIGNMENT ONLY. CHAINAGES AND LEVELS FOR THE SOUTHBOUND ALIGNMENT MAY BE DIFFERENT.
5. THIS DRAWING IS FOR INFORMATION ONLY AND DOES NOT FORM PART OF THE CONTRACT.

Client

LOWER THAMES CROSSING

5th Floor Beaufort House
15 St Botolph Street
London EC3A 7DT

Project **LOWER THAMES CROSSING DEVELOPMENT PHASE**

Drawing title **MAIN CROSSING PLAN & PROFILE CATERPILLAR OPTION (NORTH)**

| Status | | Original Size | Revision |
|---------------------|-----|-------------------|----------|
| Fit for Information | | A1 | P01 |
| Scale AS SHOWN | | Date - 05/04/2022 | |
| Drawn | RT | Date - 05/04/2022 | |
| Checked | NP | Date - 05/04/2022 | |
| Approved | JBG | Date - 05/04/2022 | |
| Drawing number | | | |

Annex B Technical note – LTC propeller scour protection

MEMO

TITLE LTC Propeller Scour Protection
DATE 25 September 2023
TO
COPY
FROM
PROJECT NO LTC Project

ADDRESS COWI UK Ltd
24 Bevis Marks
London
EC3A 7JB
UK

TEL 020 7940 7600

WWW cowi.com

PAGE 1/15

LTC PROPELLER SCOUR PROTECTION

Contents

| | | |
|-----|--------------------------------------|----|
| 1 | Scope and key result | 2 |
| 2 | Basis | 3 |
| 2.1 | Vertical datum | 3 |
| 2.2 | Geology and navigation channel | 3 |
| 2.3 | Densities | 4 |
| 2.4 | Thames River currents | 4 |
| 2.5 | Selected design vessel | 4 |
| 3 | Propellers' scour assessment | 5 |
| 3.1 | Methodology | 5 |
| 3.2 | Propellers' power | 7 |
| 3.3 | Rock protection | 8 |
| 3.4 | Tested scenarios | 9 |
| 3.5 | Results | 10 |
| 4 | Conclusions | 13 |
| 5 | References | 15 |

1 Scope and key result

This Technical Note (TN) presents a high-level estimation of the thickness of a protection solution against potential scour from the propellers of sailing vessels in the River Thames over a stretch of the Lower Thames Crossing (LTC) tunnel crossing, see Figure 1-1. The top of the scour protection is considered to be in line at the riverbed level as shown by the red line in Figure 1-1 across the LTC stretch at the navigational channel. This red line is at an elevation -12.5mCD.

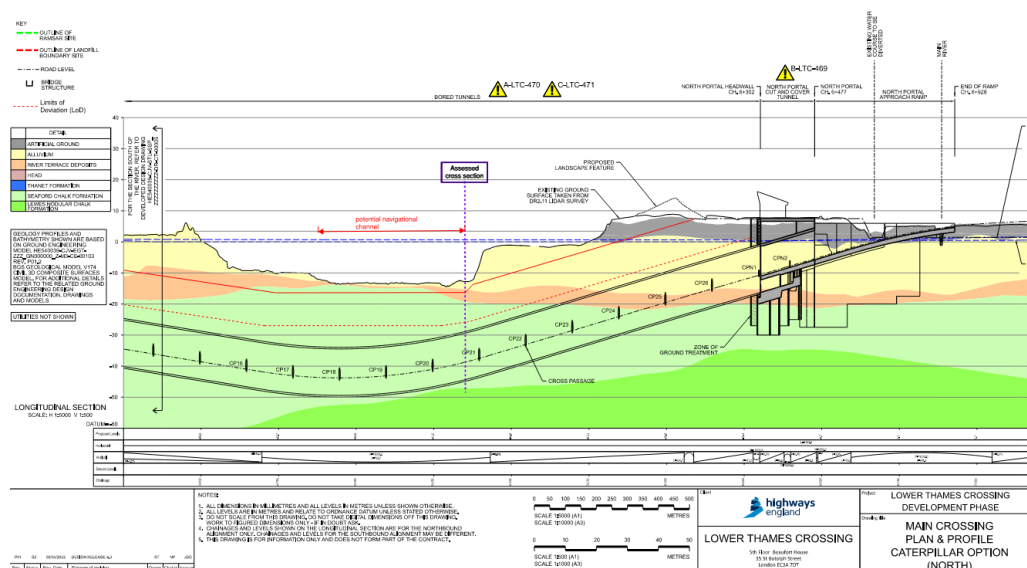

Figure 1-1 LTC crossing – main profile

The estimation below considers a conventional scour protection consisting of rocks. There are other scour protection options which require a smaller dredging depth than rock (see below, as extracted from PIANC 180, 2015); however, the design of these is less reliable as methodologies are not standardized. These are hereby listed but not considered.

- > Rock grouted with liquid asphalt
- > Rock grouted with hydro concrete
- > Concrete block mattresses
- > Concrete slabs
- > Concrete mattresses
- > Fibrous open stone asphalt mattresses
- > Geosynthetics and geosystems
- > Soft soil improvement

At this stage and for the purpose of this Technical Note, our estimations have been carried out at a high-level; they are based on wide assumptions, particularly with respect to the vessels' characteristics and the sailing speed. The information which

forms the basis of the calculations is presented in Section 2 of this Technical Note. The calculations refer to the sizing of the rocks that could withstand the estimated velocities from the action of the sailing vessels' propellers and/or a current flow velocity along the river. No assessment of other impacts, future scenarios and/or the potential seabed lowering for other reasons are included in this assessment. Section 3 presents the results and Section 4 the recommended thickness of the rock layer which should be considered as part of the checks in respect to the tunnel stability. Based on this approach, the results show that a potential scour protection solution should be 1.3m thick; it would consist of a double armour layer of rocks 60-300kg, 0.8m thick, and a granular filter layer, 0.5m thick (see Section 4). The latter could be disregarded in cases where the chalk layer is compact (i.e. not granular rock but solid rock). This case has been assumed at this stage as worst case with the view that thinner scour protection measures could be considered in the future or optimised based on further data on potential propellor speeds along with other parameters.

Should scour protection be required in the future, design studies, potentially including numerical or physical modelling, would be required, together with the collection of more data on the design vessel(s) and flow conditions.

2 Basis

2.1 Vertical datum

All elevations are related to CD, this coinciding with LAT. Tidal levels are shown Table 2-1.

Table 2-1 Tidal levels valid for LTC crossing. Ref

| Tide Details, referred to levels at Denton Wharf | Ordnance Datum | Chart Datum |
|--|----------------|-------------|
| Highest Recorded (1953) | 4.86 | 7.98 |
| Highest Astronomical Tide | 3.85 | 6.97 |
| Mean High Water Springs | 3.37 | 6.49 |
| Mean High Water | 2.80 | 5.92 |
| Mean High Water Neaps | 2.23 | 5.35 |
| Ordnance Datum (Newlyn) | ----- | 3.12 |
| Mean Low Water Neaps | -1.50 | 1.53 |
| Mean Low Water Springs | -2.49 | 0.63 |
| Chart Datum | -3.12 | ----- |
| Lowest Recorded (1987) | -3.85 | -0.73 |

2.2 Geology and navigation channel

Figure 1-1 provides a long section of the tunnel alignment under the River Thames. It includes the reference design alignment, Limits of Deviation (LoD), geology and the future riverbed dredged level, as agreed with the PLA. The future navigation

channel has been agreed so it can be dredged down to a level of -12.5m CD. Most of the bed material within the possible future navigation channel consists of weathered chalk, except for a small portion to the northern edge of the navigational channel directly south of Divers Shaol (and at the boundary of the navigation channel) where the chalk formation dips down, and terraced deposits/alluvium ground may be exposed to propeller wash.

2.3 Densities

Density of rock is taken as 2650 kg/m³. Density of water has been assumed as 1020 kg/m³ based on readings published by the Port of London Authority for the Gravesend Reach ([River Density Readings \(pla.co.uk\)](http://pla.co.uk)).

2.4 Thames River currents

No information about current flows in the river has been provided. For the purpose of this scour protection exercise, current flow velocities 2 knots, 4 knots and 6 knots are tested and it is assumed that such a current velocity can flow during both ebb and neap tides.

2.5 Selected design vessel

We selected a suitable vessel considered as part of the Preliminary Navigation Assessment undertaken as part of the LTC DCO submission TR010032-001502-7.15 Preliminary Navigational Risk Assessment (available at: [TR010032-001502-7.15 Preliminary Navigational Risk Assessment.pdf \(planninginspectorate.gov.uk\)](http://TR010032-001502-7.15.Preliminary%20Navigational%20Risk%20Assessment.pdf)) and the following vessels were selected for the assessment:

- > Cap Sans class vessel (container ship) with a DWT 124,435, 333m length, 48m beam and 14m draft – although this transit will be tidally restricted.
- > MSC Florentina (container ship) - DWT 85,832, 300m length, 40m beam, 9m draft (based on current transit information)
- > Yeoman Bridge (bulk carrier) - DWT 96,772, 250m length, 38m beam, 8.4m draft (based on current transit information)

Of the above, the Cap Sans container vessel is governing, given that it's the largest vessel of the three and has the deepest draft. Information about propeller power, main diameter size and relation between power and speed have not been provided. Based on COWI's database, the HMM Promise Container vessel is very similar to the Cap Sands and thus will be used as reference for obtaining the missing information (see below).

| Vessel characteristic | | | | | Main propulsion | | | | Bow Thruster(s) | |
|-----------------------|--------------|--------------|-------------|-------------|-----------------|---|------------------|------------------------|-----------------|------------------|
| Vessel name | TEU | Loa [m] | Beam [m] | Draught [m] | Type | Power rpm coefficient (k) kW/rpm ³ | Power, each [kW] | Propeller diameter [m] | Number | Power, each [kW] |
| KMTC Tokyo | 1800 | 172 | 27.4 | 8.75 | 1 x FPP | 0.0125 | 11960 | 6.6 | 1 | 1000 |
| SITC Cebu | 2400 | 189 | 32.2 | 9.5 | 1 x FPP | 0.0150 | 13700 | 7.4 | 1 | 1100 |
| Ever Bliss | 3000 | 211.9 | 32.8 | 10 | 1 x FPP | 0.0322 | 24260 | | 1 | 1500 |
| Polar Mexico | 3800 | 230.0 | 37.3 | 9.5 | 1 x FPP | 0.0260 | 19620 | 7.9 | 1 | 2000 |
| Cap Arnauti | 6600 | 271.0 | 42.8 | 13 | 1 x FPP | 0.0570 | 27060 | 8.8 | 1 | 2150 |
| HMM Promise | 11000 | 330.0 | 48.2 | 13 | 1 x FPP | 0.0930 | 42310 | 9.7 | 1 | 3000 |

In summary, the design ship considered for the propeller scour calculations has the following characteristics:

- > Vessel Type = Container vessel
- > DWT (deadweight tonnage) = 11,000 TEU
- > LOA (length overall) = 333 m
- > Beam = 48 m
- > Max. allowed draft at full load = 14 m
- > Power = 43,000 kW
- > Propeller diameters = 9.7m
- > Number of propellers = 1
- > Rudder = present
- > Maximum design speed = 22 knots

The design assumptions for ship size and transiting speed were confirmed through email correspondence with the PLA 03/10/23.

3 Propellers' scour assessment

3.1 Methodology

The method used for the assessment of the propeller jet is based on the PIANC 180. The centreline velocity is calculated from:

$$V_o = c \left(\frac{\% P_d}{\rho_w D_p^2} \right)^{1/3}$$

- where
- V_o is centreline velocity
 - P_d is the engine power
 - $\%$ is the percentage of the engine power applied
 - D_p is the propeller diameter
 - $c = 1.48$ for a non-ducted propeller

The percentage of power applied depends on the speed, see section 3.2.

For flow along the axis this is:

- > $V_{axis} = V_0$ in the zone of flow establishment, $\frac{x}{D_p} < 2.6$
- > $V_{axis} = 2.6 V_0 \left(\frac{x}{D_p}\right)^{-1}$ in the zone of free jet propagation, $2.6 < \frac{x}{D_p}$
- > $V_{axis} = AV_0 \left(\frac{x}{D_p}\right)^{-a}$ in the zone of restricted jet propagation

Where, x is the horizontal distance from the main propeller along the centreline; A and a are calculated as follows:

- > $A = 1.88 \exp\left(-0.061 \frac{h_p}{D_p}\right)$ propeller with a central rudder
- > $A = 1.88 \exp\left(-0.092 \frac{h_p}{D_p}\right)$ propeller without a central rudder
- > a=0.6 for jets restricted by the sea/riverbed
- > a=0.3 for in case of a nearby lateral quay wall

where h_p is the distance of the propeller axis from the seabed.

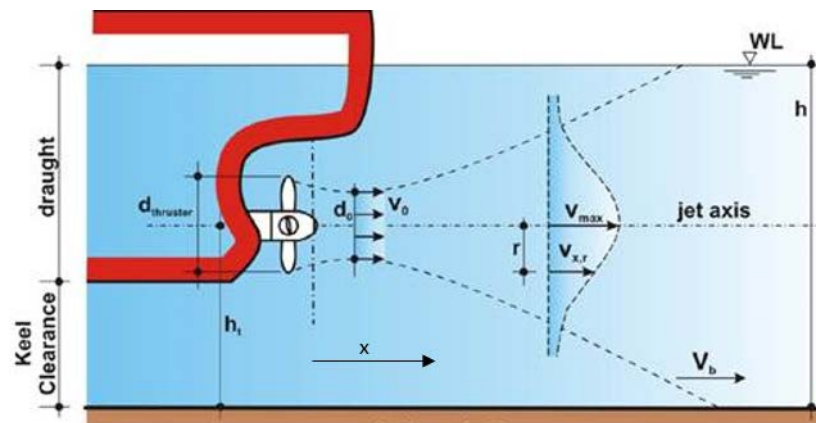

Figure 3-1 Velocity distribution behind main propeller (PIANC 180).

The flow distribution of the jet along the water column can be estimated as follows:

$$V(x, r) = V_{\text{axis}} \exp\left(\frac{-22.2 r^2}{x^2}\right)$$

where $V(x, r)$ is the velocity at location (x, r) ; r is the radial distance to the propeller axis. The flow axis is deflected downwards by 12° due to the presence of a rudder.

For a sailing vessel ($V_s \neq 0$), the velocity at the riverbed needs to consider the speed of the vessel (V_A). We adopt the following (BAW 2010):

$$(V_0)_{V_s \neq 0} = (V_0)_{V_s = 0} - \frac{1}{3} V_A \quad \text{for free propellers}$$

There is currently no methodology in the PIANC 180 for how to consider for opposing currents in the calculation of the final velocity on the riverbed. For the present assessment it will be considered that the effect of the opposing current is to reduce the speed of the vessel (the V_A) and thus increase the V_0 in the equation above.

The calculation of the stable rocks' size for the scour protection is based on the German stability approach stated in the PIANC 180, where the critical velocity of a rock on the seabed is calculated based on the below:

$$v = B_{\text{crit}} \sqrt{D_{85} \cdot g \cdot \Delta}$$

where:

B_{crit} is a coefficient set to 1.6

Δ is the relative buoyancy calculated as $\left(\frac{\rho_r}{\rho_{sw}} - 1\right)$

D_{85} is the rock particles' size for which 85% by weight of particles are smaller.

3.2 Propellers' power

The PIANC 180, 2015 gives examples of propeller power % usage depending on the ship operations, see Table 3-1.

Table 3-1 Propeller power as a function of vessel operations

| manoeuvre | EAU [2004] | | PIANC [1997] | | New PIANC recommendations*[2011]* | | | | | | |
|-------------------------------|------------|-----------|--------------|-----------|-----------------------------------|------------------------|------|------|-------------------|-------|------|
| | rpm [%] | power [%] | rpm [%] | power [%] | rpm [%] average | Standard deviation rpm | rpm | | power [%] average | power | |
| Manoeuvre | | | | | | | μ-2σ | μ+2σ | | μ-2σ | μ+2σ |
| Max. installed power | | | 100 | 100 | 100 | | | | 100 | | |
| Full ahead - service speed | 100 | 100 | 85-87 | 51-73 | | | | | | | |
| Full ahead – manoeuvring | | | 57-63 | 18-25 | 65 | 10 | 44 | 86 | 28 | 9 | 63 |
| Half ahead | 82-87 | 55-65 | 43-48 | 8-11 | 53 | 8 | 37 | 69 | 15 | 5 | 32 |
| Slow ahead | 40-50 | 6-12 | 29-32 | 2-3 | 41 | 5 | 31 | 51 | 7 | 3 | 13 |
| Dead slow ahead | 30-35 | 3-4.3 | 14-16 | 0.3-0.4 | 30 | 4 | 22 | 38 | 3 | 1 | 5 |
| Recommendations for manoeuvre | 75 | 42 | 46 | 10 | 35-55 | | | 5-15 | | | |

Thus, for instance, at full speed ahead a vessel will typically use about 50-75% of their power with this lowering to 30% or less during manoeuvring.

A vessel of the size we have considered herein is expected to be able to have speed up to about 22 knots. A 12 knots speed is thus quite low, less than 50% of the design speed.

The speed (V) - power (P) relationship of a sailing ship can be approximated with $P \approx V^\alpha$. The relation is based on the still water resistance, dependent on the water density ρ_w , the wetted surface area S_w , and the total resistance coefficient C_t . The exponent α on the velocity is typically 3.

$$P_e = \frac{1}{2} \rho_w S_w C_t V^3$$

A study by H. Berthelsen, Ulrik D. Nielsen, 2021 would show that depending on the vessel type, the factor α can be lower and that the exponent is also a function of the vessel speed. For the present assessment, the exponent of 2 will conservatively be used, thus for example at 12 knots the propeller power usage is 30%.

3.3 Rock protection

The rock protection is to be placed in two layers. It is anticipated that a filter layer would be required between the rock layer and the underlying bed material should this be granular. A filter is considered for the estimation of the total thickness of the potential scour protection layer.

The following rock classes have considered for the propeller scour protection:

- > 200-500kg
- > 60-300kg
- > 40-200kg
- > 10-60kg
- > 5-40kg

Except for the 200-500kg, all other rock gradings are "standard grading" according to the EN-13383-1. Grading requirements for standard armour rocks are presented in Table 3-2. For the definition of ELL, NLL, NUL and EUL for Non-Standard gradings, reference is made to the CIRIA Rock Manual.

Table 3-2 Rock gradings for standard rock sizes

| Light | Class designation | ELL | NLL | NUL | EUL | M_{en} | |
|-------|-------------------------|---------|----------|----------|----------|----------------|----------------|
| | Passing requirements kg | < 2% kg | < 10% kg | > 70% kg | > 97% kg | lower limit kg | upper limit kg |
| | 60-300 | 30 | 60 | 300 | 450 | 130 | 190 |
| | 10-60 | 2 | 10 | 60 | 120 | 20 | 35 |
| | 40-200 | 15 | 40 | 200 | 300 | 80 | 120 |
| | 5-40 | 1.5 | 5 | 40 | 80 | 10 | 20 |
| | 15-300 * | 3 | 15 | 300 | 450 | 45 | 135 |

The propeller scour formula by PIANC 180 uses the W_{85} (see Section 3.1) to identify the required rock size, this being the mass for which 85% of the rock material is lighter. Based on the CIRIA, The Rock Manual, W_{85} can be calculated using the Rossin-Rammler formula. Values for the W_{85min} considered for the propeller scour calculations are shown in Table 3-3.

Table 3-3 W_{85_min} . used in propeller scour calculations. Corresponding Dn_{50} (average) is also shown

| Rock Class | $W_{85} (kg)_{min.}$ | $Dn_{50} (m)$ |
|------------|----------------------|---------------|
| 200-500kg | 381 | 0.51 |
| 60-300kg | 233 | 0.41 |
| 40-200kg | 158 | 0.36 |
| 10-60kg | 44 | 0.24 |
| 5-40kg | 25 | 0.22 |

3.4 Tested scenarios

Calculations are based on the most recent guidance including PIANC 180.

The following scenarios have been assumed:

- > Vessel speed 8 knots, 10 knots, 12 knots and 16knots. It is noted here that a speed of 8 knots or 10 knots is considered a sensible assumption from marine traffic perspective and considering we would expect vessels to slow down when going into Tilbury. However, PLA will need to assist with actual design criteria. Greater speeds, as for instance 16 knots, are not considered realistic but have been added to show the impact on the scour protection sizing.
- > No current flow in the river or opposing current flows with velocities of 2 knots, 4 knots and 6 knots. It is noted that current velocities of 2 and 4 knots are considered more sensible values, but PLA would need to assist with design flow conditions.
- > Bed elevation -12.5mCD

A scenario with the vessel stopped over the tunnel and starting up engines is considered as an accidental scenario and thus ignored in the present estimations.

3.5 Results

For each scenario, the minimum required water level required was calculated for each of the 5 rock classes in Table 3-3. The water level includes the squat of the vessel, which depends on the speed and thus the ship propeller power. A dynamic underkeel clearance is calculated when the vessel is moving and thus includes for squat (squat is calculated for a blockage coefficient 0.7 based on Barrass method). The dynamic underkeel clearance is limited by a minimum of 0.7 m.

Results for each vessel's speed are presented in Figure 3-2, Figure 3-3, Figure 3-4 and Figure 3-5. These graphs can be used to determine the "window of opportunity" for safe passage of the particular vessel selected in this study at a given water level, current speed and rock size selected for the scour protection at bed level. It is noted that an opposing current results in increased velocities on the seabed; therefore this is a conservative approach.

As an example, consider the design vessel is sailing at a speed of 10 knots in Figure 3-3 and the opposing current is 2 knots. If the scour protection consists of 60-300kg rock grading, the minimum water level that needs to be present at the time of passage is +3.7m (in Figure 3-3 dark blue dashed line). If the water level is below that, then the 60-300kg rock will not be stable. If the current is 4 knots instead, then the minimum water level increases to +4.2m based on Figure 3-3 (orange dashed area). It should be noted that the current speed will vary throughout a tidal window, thus calculations of the window of navigation shall consider both water levels and associated current velocities.

For a more extreme vessel speed of 16 knots, it can be seen in Figure 3-5 that the five rock sizes considered are only adequate for a water depth near to mean high water. The current speed is likely to be low when near high tide which means the higher current speeds could be shown to not coincide with the water levels. Despite this it can be seen in Figure 3-5 that the period in which the vessel can safely pass without compromising the scour protection would be highly restricted for such a high vessel speed.

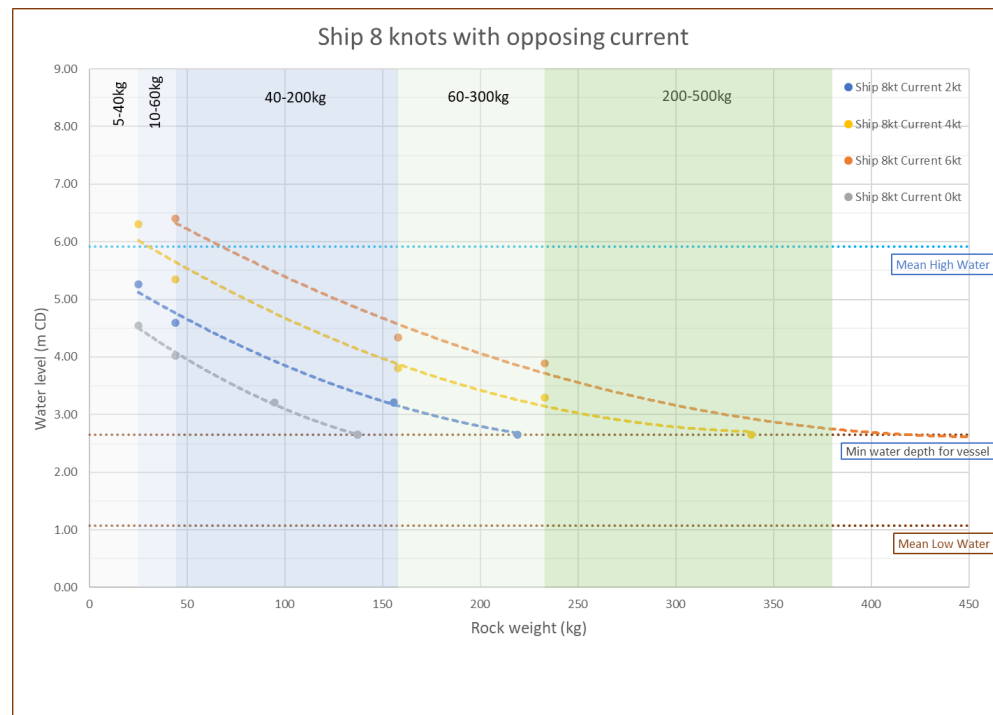

Figure 3-2 Water levels calculated for different rock classes for a vessel sailing at a SWT=8 knots and four opposing current speeds (0, 2, 4 and 6 knots).

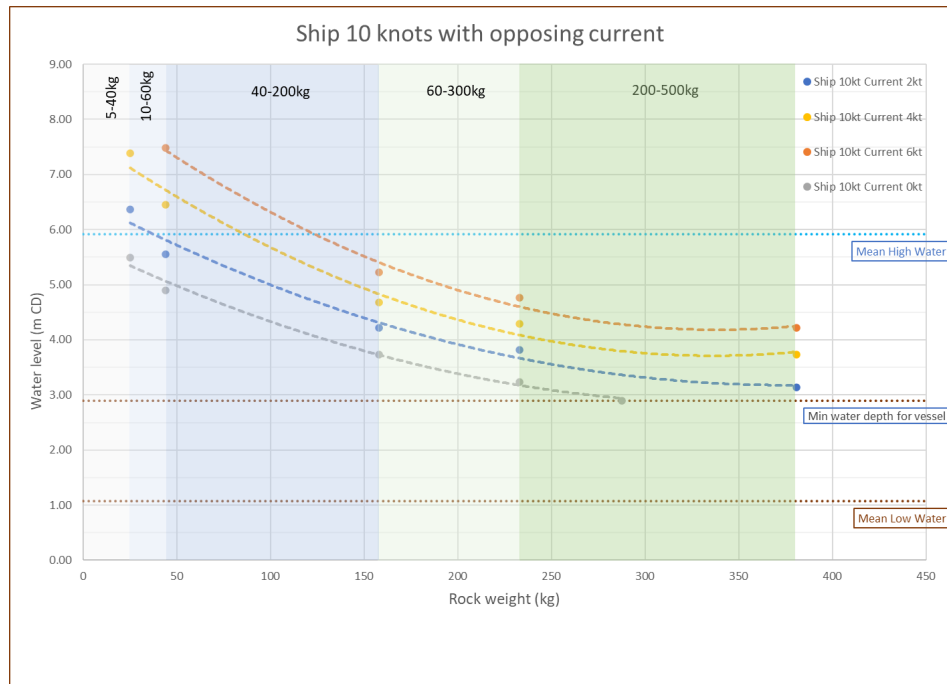

Figure 3-3 Water levels calculated for different rock classes for a vessel sailing at a SWT=10 knots and four opposing current speeds (0, 2, 4 and 6 knots).

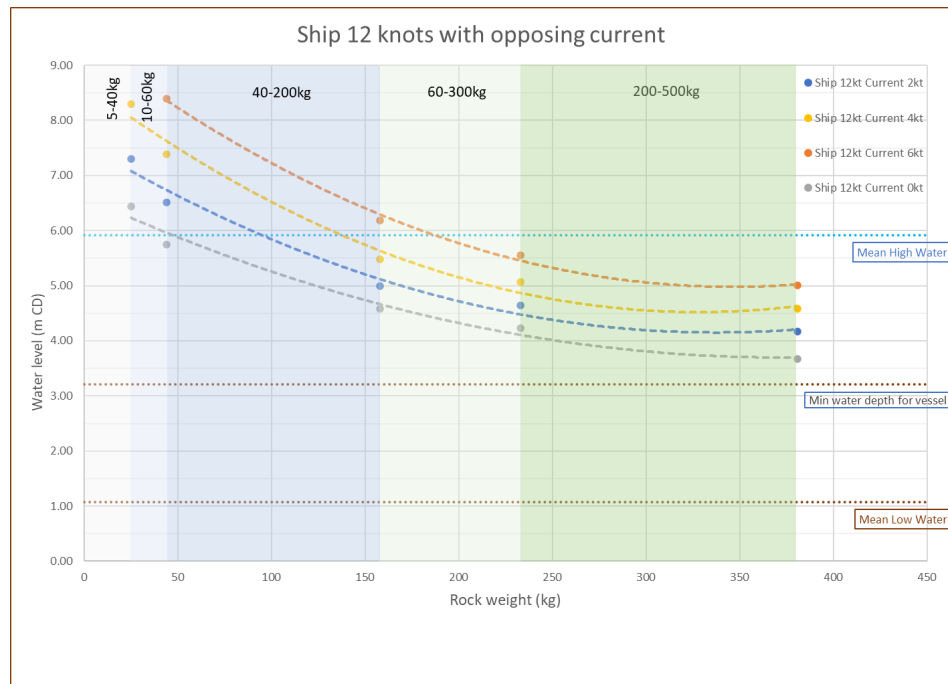

Figure 3-4 Water levels calculated for different rock classes for a vessel sailing at SWT=12 knots and four opposing current speeds (0, 2, 4 and 6 knots).

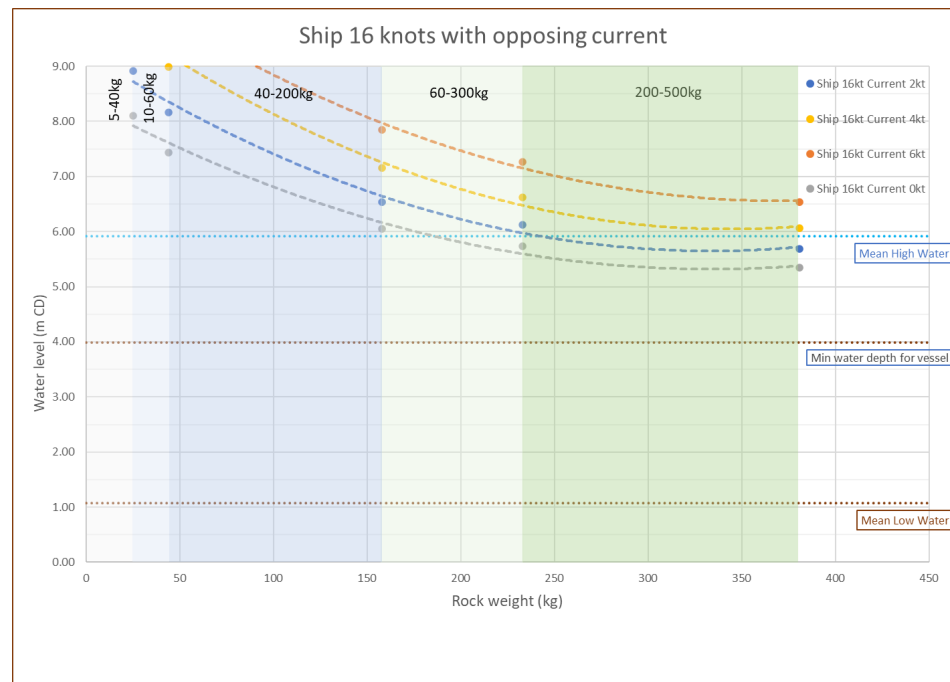

Figure 3-5 Water levels calculated for different rock classes for a vessel sailing at SWT=16 knots and four opposing current speeds (0, 2, 4 and 6 knots).

4 Conclusions

Wide assumptions have been made regarding the vessels’ characteristics such as speed and propeller(s) and power usage as well as the presence of opposing currents in the river, given the uncertainty in the type of vessels potentially using the channel in the future.

Our estimations consider a conventional scour protection type consisting of rocks ie. a solution that requires some dredging for the accommodation of the rock layers. The results for our tested scenarios showed that a scour protection solution could be 1.3m thick in total; it would consist of (from top to bottom):

- > a double armour layer of rocks 60-300kg, 0.8m thick.
- > a granular filter layer, 0.5m thick (assuming that the material on top of which it's placed is also granular).

Rocks of that size, 60-300kg, can withstand the propellers’ velocity from the considered vessel with a sailing speed 8knots at a minimum water level +2.8mCD and assuming an opposing current of 2knots (see Figure 3-2). It is estimated stable for increased vessel’s sailing speed (10, 12, 16knots) but at higher water levels (see Figures 3-3 to 3-5).

This is a high-level estimation of the required rock size and specific design conditions and criteria should be set up, together with further studies, should the concept be brought up to further design stages.

There are other scour protection options which require a smaller dredging depth (see below, as extracted from PIANC 180); however, these are not conventional and their performance should be further investigated. These are not considered herein.

- > Rock grouted with liquid asphalt
- > Rock grouted with hydro concrete
- > Concrete block mattresses
- > Concrete slabs
- > Concrete mattresses
- > Fibrous open stone asphalt mattresses
- > Geosynthetics and geosystems
- > Soft soil improvement

With respect to the existing geology, it is noted the existing riverbed is chalk (which is rock). Scour in rock is a slow process, especially when it's not constant. The navigation channel is around 475m wide. It is thus unlikely that the vessel will be passing over the same trajectory. Also, given that the vessel is moving, the duration of the propeller jet over the same location is in the order of seconds. Finally, the number of times that the design vessel will pass within the navigation channel at low water is limited by the water depth present before and after the LTC crossing. It is not known if the -12.5mCD minimum dredging level applies to a wide stretch along the river, from the sea to the mooring location or only to the tunnel.

In conclusion, the estimated thickness of 1.3m is considered as an upper estimate required to install scour protection on the basis that if required then a thinner solution could be considered by using a different system or the assumed parameters are considered further to optimise the loadings through data or model testing. Also, part of the channel when exposed at the depths where scour protection required will be chalk and therefore more stable than part of the channel will not require any further protection over the part of the channel where LTC crosses under the River Thames.

5 References

- [1] PIANC, 2015. Report N°180 - Guidelines for protecting berthing structures from scour caused by ships. PIANC Secrétariat Général, Brussels. ISBN 978-2-87223-223-9
- [2] PIANC, 2017. Errata Corrige – Guidelines for protecting berthing structures from scour cause by ships n.180
- [3] BAW 2010. Principles for the Design of Bank and Bottom Protection for Inland Waterway
- [4] CIRIA C683, 2007. The rock manual: the use of rock in hydraulic engineering (2nd edition)
- [5] H. Berthelsen and U.D. Nielsen, 2021. Prediction of ships' speed-power relationship at speed intervals below the design speed, Transportation Research Part D: Transport and Environment, Volume 99, October 2021
- [6] TR010032-001502-7.15 Preliminary Navigational Risk Assessment, 2022. APFP Regulation 5(2)(q), Application Document Ref: TR010032/APP/7.15, Version 1.0. Available at: ([TR010032-001502-7.15 Preliminary Navigational Risk Assessment.pdf \(planninginspectorate.gov.uk\)](#)), accessed in October 2023
- [7] PLA, River density readings. Available at: [River Density Readings \(pla.co.uk\)](#), accessed in October 2023

If you need help accessing this or any other National Highways information, please call **0300 123 5000** and we will help you.

© Crown copyright 2023.

You may re-use this information (not including logos) free of charge in any format or medium, under the terms of the Open Government Licence. To view this licence:

visit www.nationalarchives.gov.uk/doc/open-government-licence/

write to the **Information Policy Team, The National Archives, Kew, London TW9 4DU**, or email psi@nationalarchives.gsi.gov.uk.

Mapping (where present): © Crown copyright and database rights 2023 OS 100030649. You are permitted to use this data solely to enable you to respond to, or interact with, the organisation that provided you with the data. You are not permitted to copy, sub-licence, distribute or sell any of this data to third parties in any form.

If you have any enquiries about this publication email info@nationalhighways.co.uk or call **0300 123 5000***.

*Calls to 03 numbers cost no more than a national rate call to an 01 or 02 number and must count towards any inclusive minutes in the same way as 01 and 02 calls.

These rules apply to calls from any type of line including mobile, BT, other fixed line or payphone. Calls may be recorded or monitored.

Printed on paper from well-managed forests and other controlled sources when issued directly by National Highways.

Registered office Bridge House, 1 Walnut Tree Close, Guildford GU1 4LZ

National Highways Limited registered in England and Wales number 09346363